

# **Competition Rules for GeoWall**

## **ASCE Frontier Student Symposium**

**2025**

## Student Symposium Rules

The ASCE Frontier Student Symposium's Geowall competition are the same as the Geo-Institute of the American Society of Civil Engineers 2025 Competition Rules for the National GeoWall (Attachment A) with a couple of small changes. This is to allow teams to easily compete in both the national competition as well as the regional competition. The changes to the rules are outlined in the following sections. Unless otherwise stated, all other rules and requirements remain the same.

## Exceptions

Changes made to the National Rules sections are outlined below.

### 4. Design Report Submittal

The Design Report will be replaced with a Design Sheet. The Design Sheet shall be as follows:

Each team shall prepare a design sheet summarizing their design. The sheet must include:

- a) School Name
- b) Names of all team members
- c) The mass of the reinforcement material as designed in grams
- d) A copy of Appendix E: Safety Appendix.

Each team will submit their Design Sheet during the Captain's Meeting.

### 5. National Competition Selection

This section is not applicable to the Frontier Student Symposium's Geowall competition.

### 14. Pre-Competition Team Captains' Meeting

The National Rules section will be replaced with the following:

A team captains' meeting will be held prior to the competition for the purposes of: checking sandboxes and PVC pipe for compliance if provided by the invited design teams, establishing competition order, submission of Design Sheet and Appendix E, and disseminating any logistical or administrative information. This is a MANDATORY meeting. Each team must have the team captain (or designee) present. All team members are encouraged to attend. Specific meeting time and

location will be listed in the symposium schedule before the conference. Teams without a representative at the captains' meeting may be disqualified.

Teams must bring their sandboxes, PVC tunnel, PVC piles, any hardware or tools needed for assembly, and all temporary templates that will be used in any stage of the competition. Sandboxes, tunnels, and piles should be assembled and will be checked for compliance at the meeting.. Teams will have until 8 :45 am local time of the day of the competition to correct any compliance issues identified during the captains' meeting. Any sandboxes, tunnels, or piles found out of compliance at the captains' meeting will be rechecked at this time.

## **Appendix A: Reimbursements**

This section is not applicable to the Frontier Student Symposium's Geowall competition.

## **Appendix C: Design Report Judging Rubric**

This section is not applicable to the Frontier Student Symposium's Geowall competition.

## **Appendix F: Bio-form to be completed by the team captain and submitted to the head judge at the pre-competition meeting**

This section is not applicable to the Frontier Student Symposium's Geowall competition.

## **Appendix G: Bio-form to be completed by each team member and submitted to the head judge at the pre-competition meeting**

This section is not applicable to the Frontier Student Symposium's Geowall competition.

# Attachment A



**GEO-  
INSTITUTE**



# The Geo-Institute

**of the American Society of Civil Engineers**

**Presents**

## **Competition Rules for the National GeoWall**

**Held During**

**Geotechnical Frontiers 2025**

### **Important Dates**

**Rules published:** September 12, 2024

**Design papers due:** December 20, 2024

**Finalists notified:** January 17, 2025

**Pre-Competition Captains' Meeting:** March 2, 2025

**Competition:** March 3, 2025

**Geotechnical Frontiers 2025 Information:** <https://geotechnicalfrontiers.com/>

**GeoChallenge Official Information Site:**

<http://www.mygeoworld.info/groups/profile/61033/geochallenge>

Revision 01: September 12, 2024



## GeoWall 2025 Competition Rules Geo-Institute of the ASCE



- Objective** – The objective of the GeoWall competition is to design and build a model mechanically stabilized earth (MSE) retaining wall using kraft paper taped to a poster board wall facing. The competition objectives are for students to:
  - Design a MSE wall using the least amount of reinforcement needed to support the retained soil plus both vertical and horizontal surcharge loads,
  - Effectively communicate their analysis and design processes,
  - Enjoy a friendly but spirited competition among schools, and
  - Attend a world-class professional engineering conference.
- Background** – MSE walls have roots to prehistoric builders who used sticks and branches to reinforce soil structures. The modern use of reinforced soils dates to the 1960s and French architect Henri Vidal's development of the Reinforced Earth® system. In the US, the first MSE wall was built on California SR-39 near Los Angeles in 1971. Sometimes the construction of MSE walls must account for underground utilities, tunnels or other obstructions (Figure 1). This year's competition will model these obstructions requiring teams to design and construct an MSE wall around a proposed tunnel.

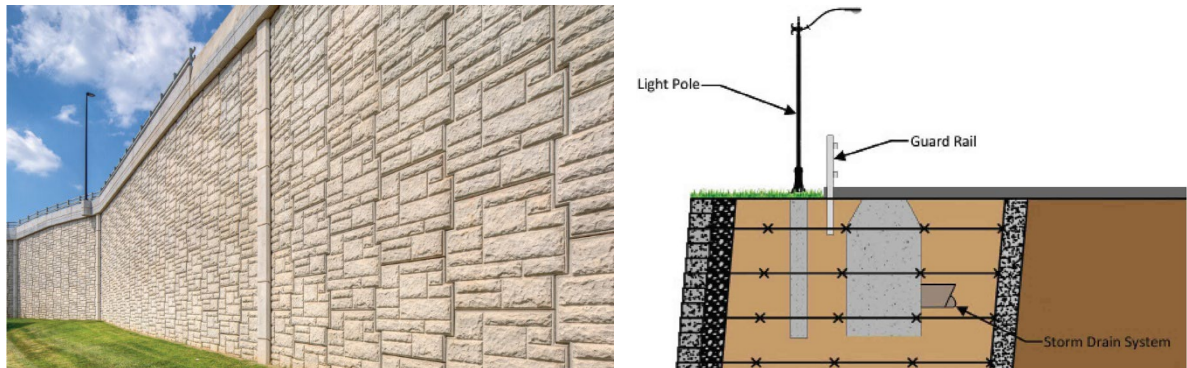

Figure 1: Examples of MSE walls

- Eligibility** – Only one team per school will be allowed to compete. A team consists of a maximum of four (4) students consisting of not more than two (2) graduate students. Each team shall designate a captain who shall be the point of contact for the team. All team members must be enrolled students at the date of the national competition.
- Design Report Submittal** – Invitation to the National Competition will be based upon submittal and ranking of the Mechanically Stabilized Earth (MSE) Wall Design Report. The report must include:
  - Cover page with name of institution; names and status (graduate, undergraduate) of each team member; identification of team captain with email address; and name, title, and email address of faculty advisor.
  - Material properties used in design including methods (lab tests, correlations, assumptions) used to obtain the properties.
  - Description of the engineering design and construction procedures including assumptions and equations used.
  - A complete description of the geometry and placement of all reinforcing elements. Estimated mass of the reinforcing paper in grams (not including facing material or tape).

- e) A safety appendix (Appendix E) which outlines the potentially hazardous tasks reasonably expected during the competition and how the team will mitigate these hazards.
- f) Completed reimbursement appendix (Appendix A) with faculty advisor signature.

Formatting requirements:

- a) Length shall be a maximum of three (3) pages long (not including references, cover page, safety appendix or reimbursement appendix). Over-length design reports will not be reviewed and will be disqualified.
- b) One-inch margins, single-spaced, and 12 point Times New Roman font.
- c) All pages after the cover page shall contain a header identifying the team and a footer with the page number.
- d) Entire design report must be submitted in a single PDF format file with a filename of <School Abbreviation>2025GeoWall.pdf.

Design reports will be judged by a panel of practicing engineers and professors. Judging will consider reasonableness of design equations, material properties, factors of safety, assumptions, and satisfaction of the objective of this competition. “Trial and error” designs will be heavily penalized. The judging rubric is presented in Appendix C.

Complete design report must be submitted in PDF format via email to Dr. Beena Ajmera ([bajmera@iastate.edu](mailto:bajmera@iastate.edu)) by 6:00 pm PST December 20, 2024. Subject line must include “GeoWall 2025 Submittal.” Sender will receive confirmation of receipt by e-mail. Any changes or corrections made to the design report after this time will incur a penalty. Late design reports will not reviewed and will be disqualified.

5. **National Competition Selection** – Up to twenty teams will be selected for the National Finals GeoWall competition based upon scores earned on the design reports.

Teams selected for National Finals must complete Appendices F and G and submit copies to Dr. Ajmera at the email address in section 4.

6. **Sandbox** – The MSE wall will be constructed within an apparatus hereafter referred to as a sandbox. Each team shall bring their own sandbox to the competition. Painting and the addition of school or sponsor logos and other decorations to the exterior of the sandbox is highly encouraged. The sandbox shall be made up of a bottom and four vertical sides with no top. The front panel will be removable as shown in Figure 2. The removable box panel will be in place during wall construction and removed after construction to expose the MSE wall. The sandbox will also include a horizontal PVC pipe used to represent a tunnel, and two PVC piles used to apply the horizontal load. Each team shall bring their own PVC tunnel to the competition. Dimensions of the sandbox, the PVC tunnel, and the PVC piles are shown in Figures 2 through 6. The sandbox shall meet the following requirements:

- a) Have exterior walls and base constructed of any grade of plywood not to exceed  $\frac{3}{4}$  inch (19 mm) thick.
- b) Have planar inside surfaces with the natural plywood finish.
- c) Have a removable front as shown in Figure 2. Panels must be flush with the base of the box and held in place with threaded inserts, screws, hinges or other easily removable fasteners.
- d) Have a full-sized base such that it extends no more than  $\frac{3}{4}$  inch (19 mm) beyond the base of the wall once the front panel has been removed.
- e) Include a steel tie rod designed to keep the two fixed sides of the box parallel after removal of the facing panel.
- f) Include a PVC tunnel (Figures 3 and 4) to represent the tunnel obstruction. Temporary templates may be used to control alignment of the pipe.

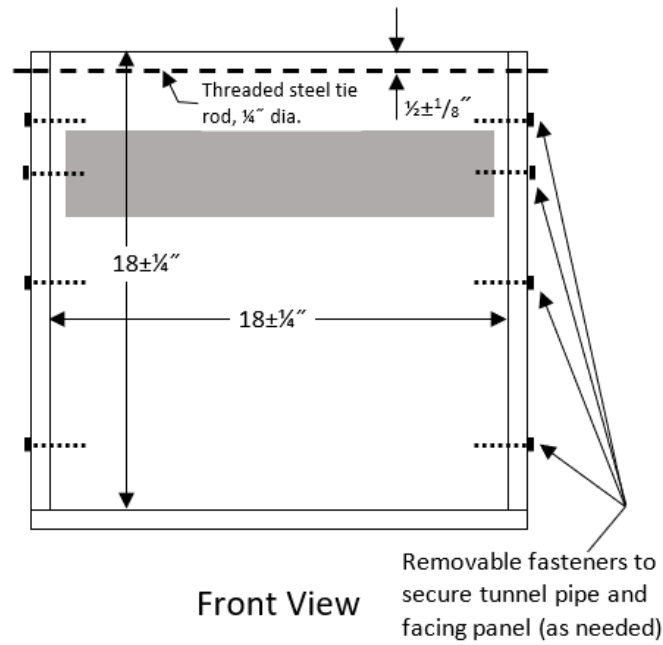
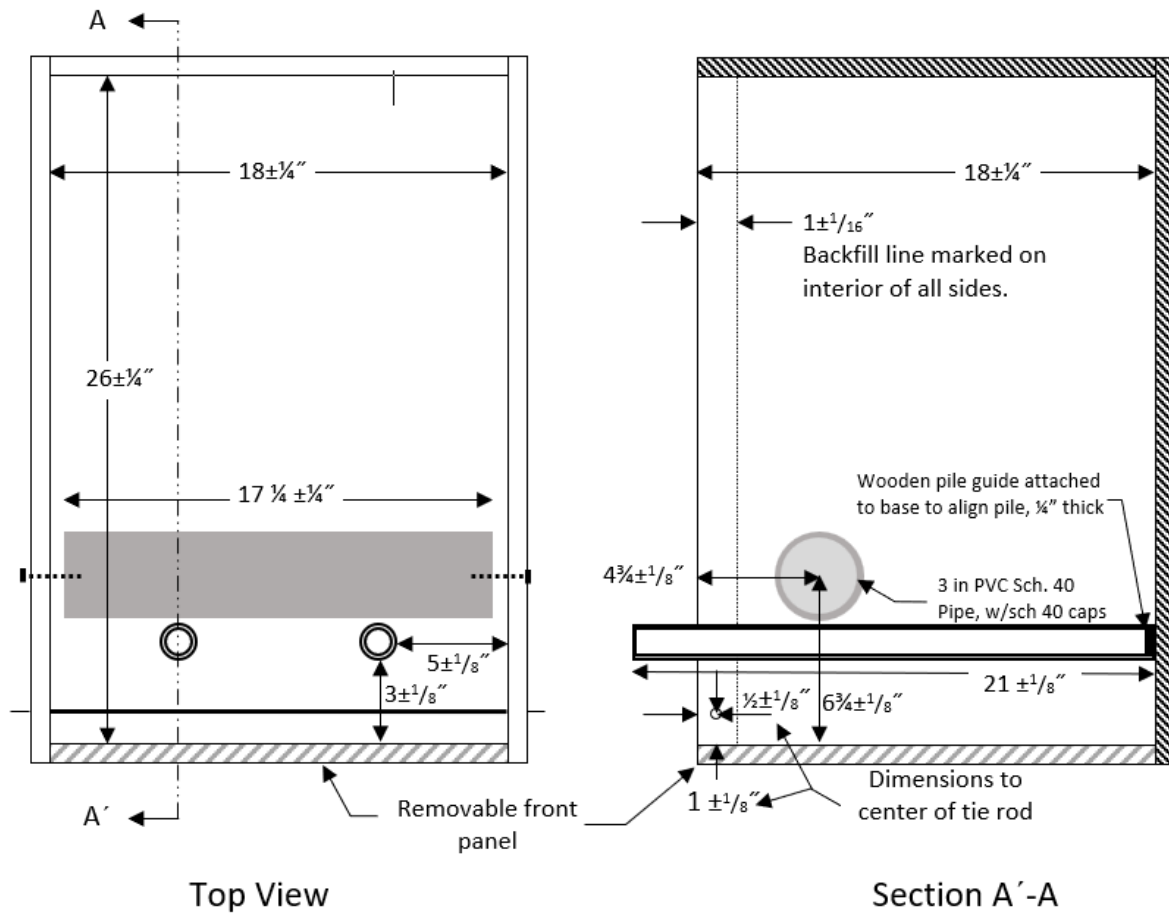

- Notes:
- Box to be fabricated of 23/32" or 3/4" plywood except as noted
  - Tie rod must be 1/4" threaded steel rod with washers and nuts as needed
  - Piles must be 1-1/2" Schedule 40 PVC and must slide over wooden guides; Piles may not be attached to guides or box.
  - Tunnel must be 3" Schedule 40 PCV
  - Handles or knobs may be attached to outside of front panel to aid in removal
  - Interior surface of box must be natural wood and unmodified
  - Exterior of box may be painted and decorated with school logos, etc.

Figure 2: Sandbox dimensions (not to scale)



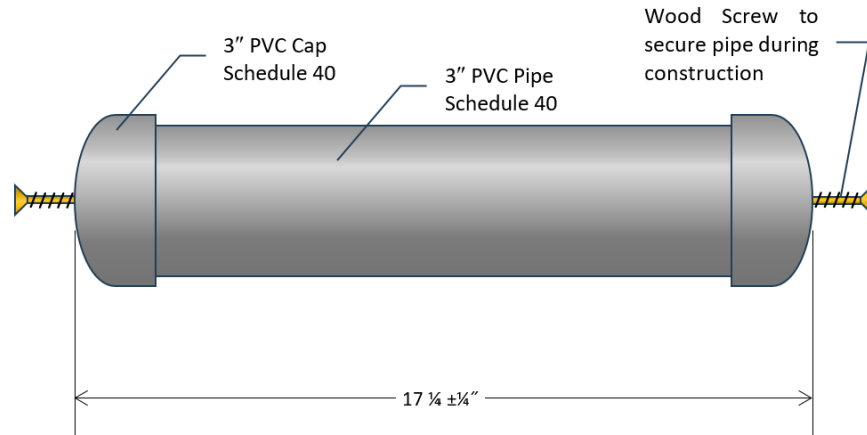

Figure 3: Dimensions of the PVC pipe (not to scale)

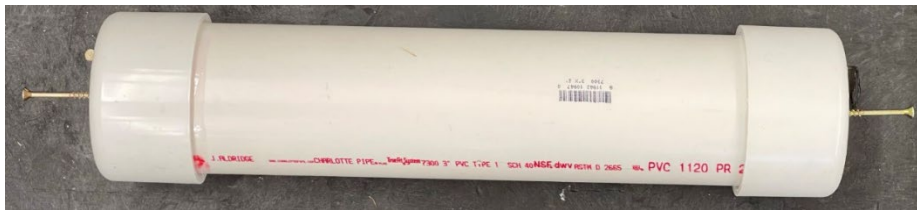

Figure 4: Picture of PVC pipe

- g) Include circular guides to ensure bases of the PVC piles are held in the correct location. A temporary template may be used to control alignment at the top of the piles.
- h) Any templates used must be removed after wall construction and before testing.
- i) All dimensions of the sandbox shall be as shown in Figure 2.

For convenience, sandboxes may be designed so they can be transported as flat pieces and reassembled at the competition site.

Sandboxes, the PVC tunnel and the PVC piles will be checked for compliance at the pre-competition captains' meeting. Teams will have until 9:45 am local time the day of the competition to correct any compliance issues. Any team with a sandbox, PVC tunnel and/or PVC piles out of compliance at the start of the competition will be penalized.

7. **Piles** –Two vertical piles will be used to apply the horizontal load to the backfill behind the wall. Each team will provide their own piles. Piles will be fabricated out of 1-½ inch schedule 40 PVC pipe. See Figure 2 for the pile locations and length requirements.
8. **Backfill Material** – The backfill material will be sand provided by competition organizers on site. The sand will be a clean, dry, rounded to subrounded sand with grain size as specified in Table 1 and Figure 7. The backfill material must be used as-is: no water, additives, or chemical stabilizers may be placed in the backfill material.

Competition organizers will make reasonable efforts to ensure the competition backfill materials meet the specifications in Table 1 and Figure 7. Teams will be allowed to examine a sample of the competition backfill at the captains' meeting. No backfill samples may be removed from the meeting room. Teams may modify their wall design at this time if they desire. See section 12 below.

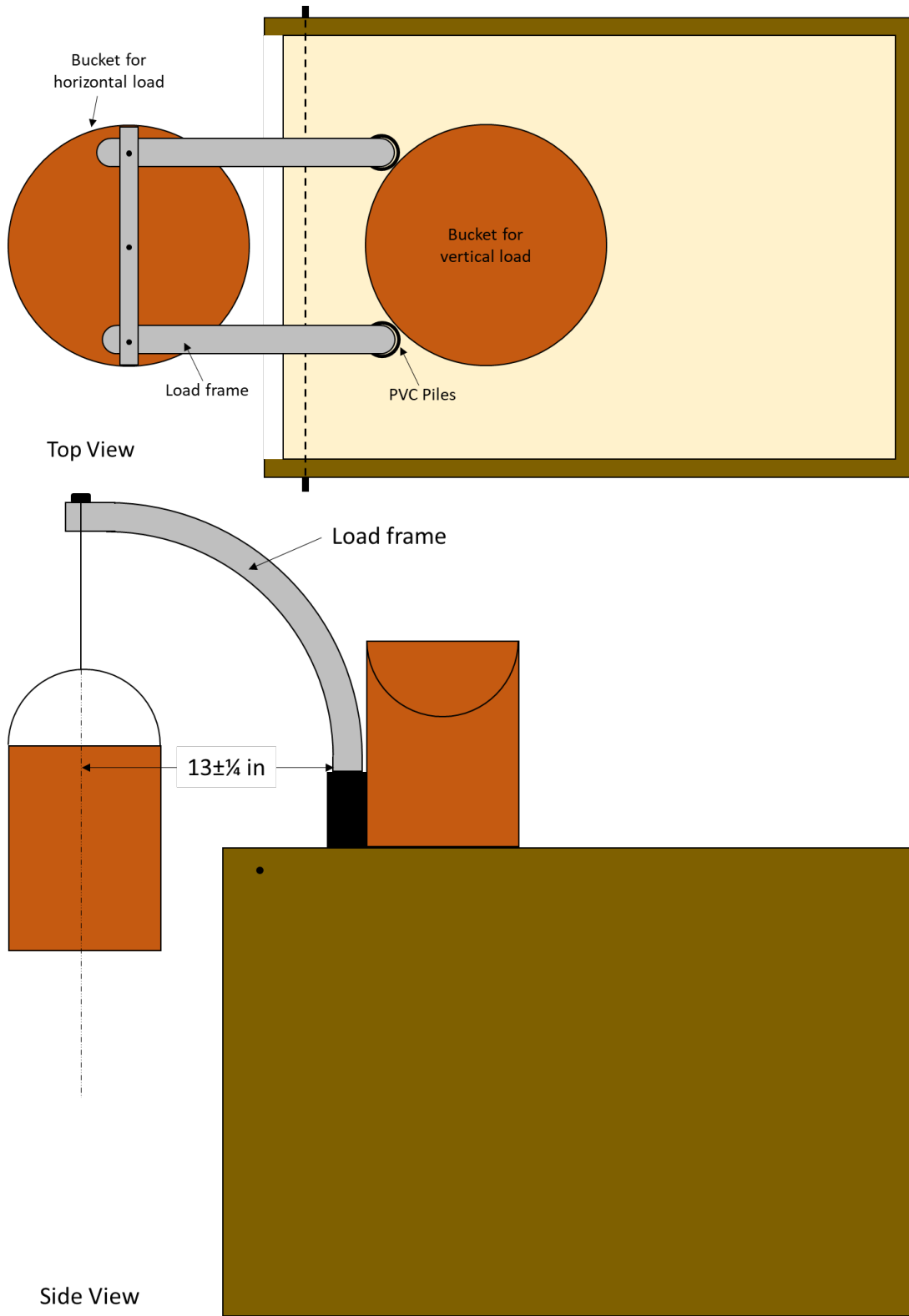
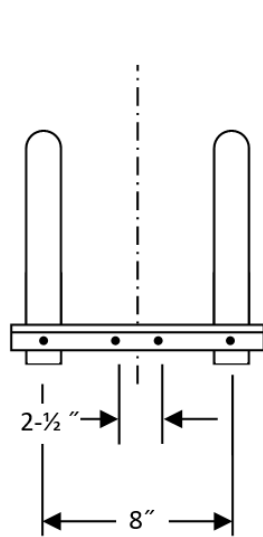
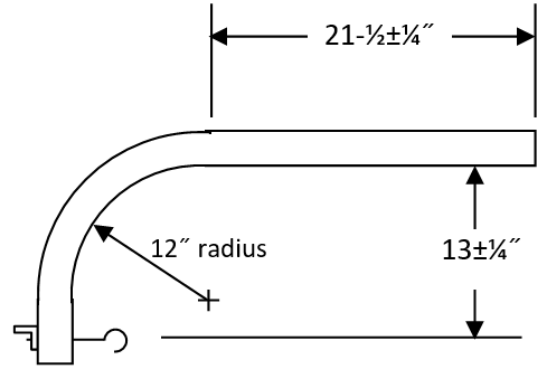

Figure 5: Load Placement (not to scale)



Top View



Side View

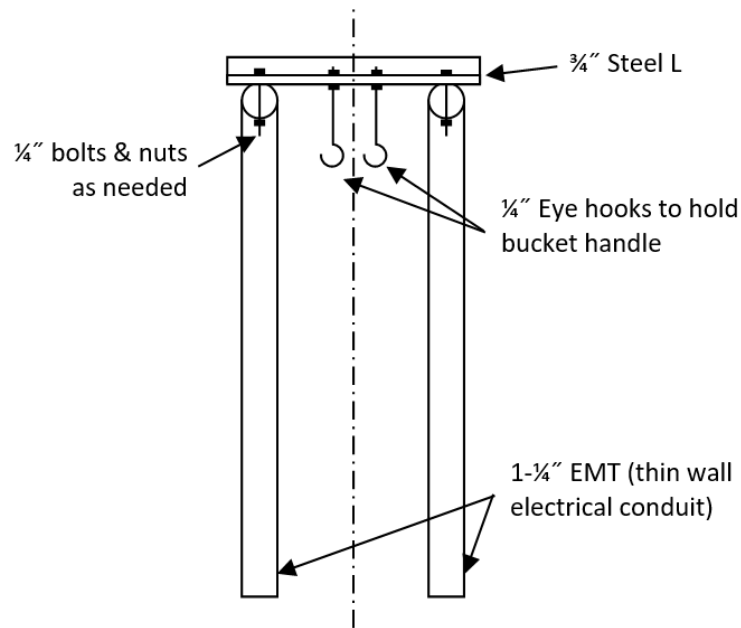

Front View

Figure 6: Dimensions of Horizontal Load Frame (not to scale)

Table 1: Representative anticipated grain-size distribution for GeoWall competition sand.

Typical Distribution		Lower Bound		Upper Bound	
Size (mm)	% Passing	Size (mm)	% Passing	Size (mm)	% Passing
2.00	100.0	1.30	100.0	2.50	100.0
1.70	96.8	1.20	96.9	2.30	96.9
1.18	41.8	1.15	93.7	2.10	93.7
1.00	15.8	0.80	38.7	1.60	38.7
0.85	3.3	0.60	12.7	1.30	12.7
		0.50	2.0	1.10	2.0

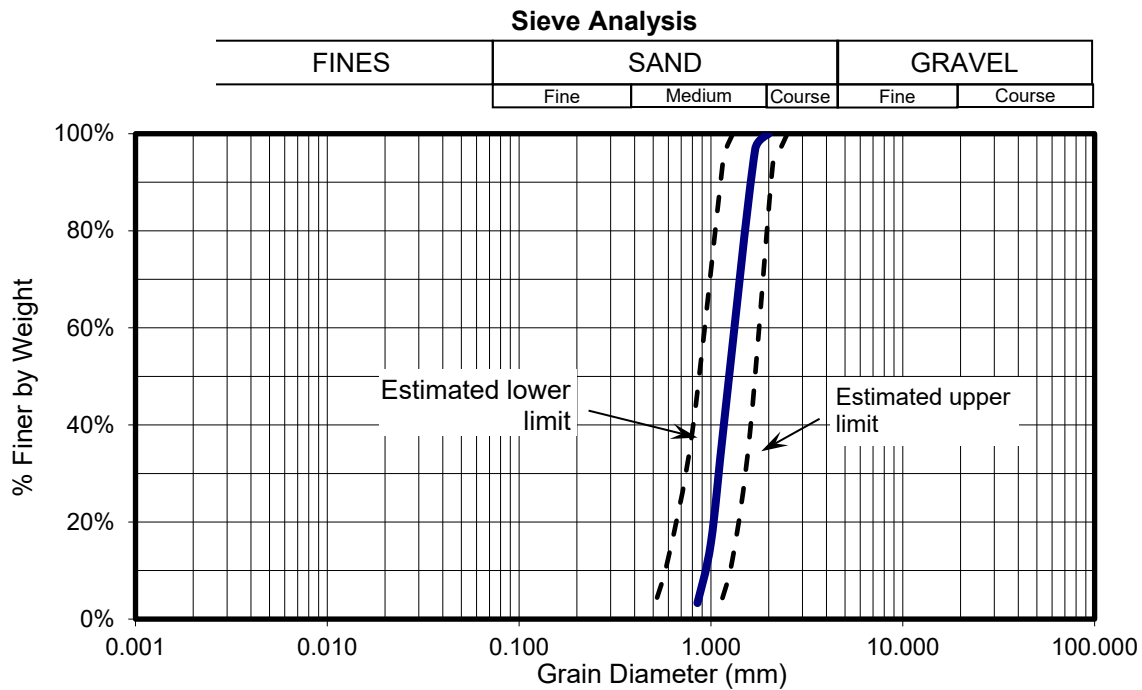

9. **Wall Materials** – Materials will be provided by competition organizers on site. See Appendix B for detailed specifications.

- a) Facing – One piece of poster board. See Figure 8 for dimensions.
- b) Reinforcement – 60 lb kraft paper. Quantity of reinforcement will be measured by mass to the nearest 0.01g. There are no restrictions on the shape or geometry of reinforcing elements, but all reinforcement must be cut from a single sheet of 24" × 24" kraft paper.
- c) Reinforcement Attachment to Facing – Heavy-duty polypropylene packing tape that is 2" wide.

Competition organizers will make reasonable efforts to ensure the wall materials meet the specifications in Appendix B. Teams will be allowed to examine small samples of the reinforcing and facing material at the captains' meeting. No reinforcing and facing material samples may be removed from the meeting room. Teams may modify their wall design at this time if they desire. See section 12 below.

10. **Construction Tools** - The following construction tools may be used and must be provided by the competing team (quantities of these items shall not be restricted):

- a) Pencils, pens, and markers

- b) Rulers and straight edges
- c) Levels
- d) Manually operated cutting instruments (e.g., scissors, utility knives, safety razor blades, hole punch)
- e) Cutting boards or mats
- f) Design notes, calculations, and drawings
- g) Material handling and compaction tools consisting of any hand operated devices.
- h) Screwdrivers (battery operated drills or screwdrivers may be used, but only to remove fasteners when removing the facing panel)
- i) Temporary templates for use in any stage of competition. These templates may be made of any material, must not have any moving parts, and must be removed at the end of any stage in which they are used.

Buckets and shovels will be provided by the competition organizers. It may be necessary for teams to haul backfill a distance up to 20 feet.

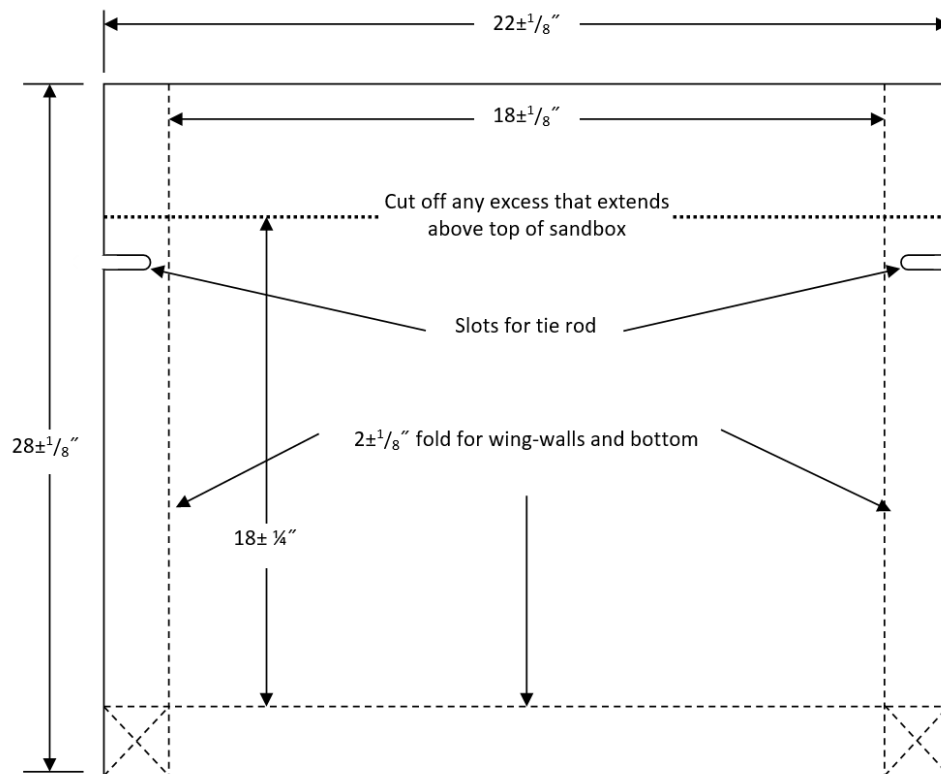

Figure 8: Dimensions of the poster board wall facing (not to scale)

#### 11. Execution – Construction and testing of the wall will be done in the following stages:

- a) **Reinforcement Fabrication Stage** – Each team will be provided with a single sheet of 60 lb kraft paper approximately 24 in  $\times$  24 in. The team must fabricate all their reinforcing elements from this sheet using authorized construction tools. Fifteen (15) minutes will be allotted for this stage. Teams will be penalized for time exceeding the time limit. After all reinforcing elements are fabricated, excess material will be disposed of and the judges will weigh the reinforcing elements to the nearest 0.01 grams.

- b) **Wall Assembly Stage** – After each team’s reinforcing elements have been fabricated and weighed, the team will be provided with a sheet of poster board (22 in × 28 in) and a roll of packing tape. The team must assemble their wall using these materials and authorized construction tools. Dimensions for the wall facing area shown in Figure 8.
- i) Tape may only be used to attach reinforcement to the wall facing in individual pieces no larger than 2 in × 2 in. The adhesive side of each piece of tape must be in contact with both the wall facing and a reinforcing element. Tape pieces may not overlap one another. All tape pieces must be placed on the vertical plane forming the wall facing only.
  - ii) Tape may not be used for any other purpose, including but not limited to: sealing corners of facing material, joining two or more reinforcing elements, anchoring material or reinforcement to the box, securing the PVC tunnel or PVC piles, anchoring facing material or reinforcement to the box.
  - iii) This is the only stage in which the team is allowed to use tape.

The wall should be trial-fitted to the sandbox during this stage. Any portion of the wall that rises above the top of the sandbox must be trimmed off. The assembly stage is complete when the facing material is properly folded and trimmed, all the reinforcing elements are attached to the facing, the wall is placed in the sandbox, and the tie rod, PVC tunnel and the PVC piles are properly in place. No sand is added to the box in this stage. Fifteen (15) minutes will be allocated for this stage. Teams will be penalized for time exceeding the time limit. Judges will check to ensure the wall is properly assembled.

- c) **Construction Stage** – After the wall is assembled and checked by the judges, the judges will instruct the team to start construction. During this stage, the team fills the box with sand so that the sand fill line (see Figure 2) is covered and the backfill is level, and an empty 5 gallon vertical surcharge bucket is placed on top of the sand centered behind the PVC piles, as shown in Figure 5. The facing material must be in direct contact with the inside of the sandbox at all times during this stage. The tie rod, PVC tunnel and PVC piles may be removed from the box at the start of this stage, but they must be in place before any sand is placed in the box. Temporary templates or guides may be used during this stage so long as they are removed before the end of the stage.

The construction stage is complete when the wall is in place, the sand backfill covers the sand fill line and is level, any temporary templates or guides have been removed, and the empty vertical surcharge loading bucket is in place. Twenty (20) minutes will be allotted for this stage. Teams will be penalized for time exceeding the time limit. At the end of the phase, judges will check fill placement and the placement of the empty vertical surcharge loading bucket to ensure that they meet the requirements.

- d) **Loading Stage** – Details of the load placement are shown in Figure 5. This stage occurs in three steps: 1) removal of tunnel restraints and front panel, 2) placement of 50 lb vertical surcharge load, and 3) placement of the 20 lb static horizontal surcharge load in an empty 5 gallon bucket on the loading frame. During each step, the wall will be checked for the following three criteria: 1) excessive deformation (any portion of the wall extending outside the imaginary plane extending vertically from base of sandbox), 2) excessive soil leakage (more than 30 cm<sup>3</sup> of sand passing out of the sandbox), and 3) catastrophic failure. The team will be penalized for excessive soil loss and excessive deformation, but will be disqualified for a catastrophic failure.
- i. When directed by the judge, the team shall remove the tunnel restraints and the front panel of the sandbox. After the panel and restraints are removed, the judge will wait one (1) minute and then check the three criteria.

- ii. If the wall does not fail catastrophically, the team will then place 50 lbs of sand in the empty 5 gallon bucket on top of the sand. The team will have one (1) minute to place the load. After the load is placed, the judge will wait one (1) minute and then check the three criteria.
- iii. If the wall does not fail catastrophically, the team will hang an empty 5 gallon bucket on the loading frame and place 20 lbs of sand in the bucket (see Figures 5 and 6). The team will have one (1) minute to complete this loading sequence. After the sequence is complete, the judge will wait one (1) minute and then check the criteria. The horizontal load frame will be provided by the competition organizers. Teams should not bring their own load frames to the competition and will not be permitted to use their own.

12. **Design Changes** – Teams may change their design between the time the design report is submitted and the wall is tested. The adjusted mass of the reinforcing material used for scoring,  $M$ , will be computed as

$$\begin{aligned}
 & \text{if } |m_D - m_A| \leq 0.25 & M &= m_A \\
 & \text{if } |m_D - m_A| > 0.25 & M &= \max \left[ \begin{array}{l} (m_D - 0.25) - \frac{(m_D - m_A - 0.25)}{2} \\ m_A + \frac{(m_A - m_D - 0.25)}{2} \end{array} \right] \quad (1)
 \end{aligned}$$

Where,

$m_D$  = reinforcing mass (g) reported in design report;

$m_A$  = reinforcing mass (g) used during competition;

$M$  = adjusted mass (g) rounded to two decimal places.

13. **Scoring** – After completion of the loading stage, the score for each team will be computed using the following formula:

$$\text{Score} = R + 15(40 - M) - 10N_{min} - 40N_{maj} - 2T - 20D \quad (2)$$

Where,

$R$  = report score out of 60 points

$M$  = adjusted mass of the reinforcement material in grams from Equation 1

$N_{min}$  = number of minor rules violations

$N_{maj}$  = number of major rules violations

$T$  = total number of minutes over time limit for all phases each rounded up to nearest minute

$D$  = deflection rating

8 if wall fails deflection criterion during initial loading without surcharge

6 if wall fails deflection criterion during vertical surcharge loading

4 if wall fails deflection criterion during horizontal surcharge loading

0 if wall passes deflection criterion for all loading phases

If the wall fails catastrophically during any loading step, the team will be disqualified.

a) **Minor Penalties**

i) Box dimension out of spec

ii) PVC tunnel location out of spec

- iii) Pile location(s) out of spec
- iv) Minor safety mishaps
- v) Lack of minimum personnel protective equipment (PPE) – See safety appendix (Appendix E)
- vi) Any addendum to the design report required by judges which simply clarifies content but does not change the design
- vii) Any other rule violation that in the opinion of the judges has the potential to provide the team with a measurable, but minor advantage

**b) Major Penalties**

- i) Soil leakage greater than 30 cm<sup>3</sup> (volume of standard 1 oz plastic medicine cup)
- ii) Improper use of adhesive tape
- iii) Major safety mishaps including any mishap that results in injury
- iv) Any addendum to the design report required by judges which results in a significant change to the design
- v) Any other rule violation that in the opinion of the judges has the potential to provide the team with a significant advantage, but does not warrant disqualification

**c) Disqualification** – Teams may be disqualified for the following:

- i) Over-length design reports
- ii) Late submission of design report
- iii) Failure to send a representative to the pre-competition captains' meeting
- iv) Unsafe practices
- v) Design or construction techniques which violate the spirit of the competition and provide a large and/or unfair advantage
- vi) Catastrophic wall failure at any point during the loading
- vii) Any other rule violation that in the opinion of the judges has the potential to provide the team with a significant advantage and warrants disqualification

Scores will be recorded to the nearest tenth of a point. In the event of a tie the following criteria will be used, in order, to break the tie: 1) lowest actual reinforcement mass, 2) higher report score, 3) lowest deflection rating, and 4) judges' consensus of best-decorated sandbox.

The judges will follow the rules as published using reasonable judgment and interpretation. The head judge will be the arbiter of any disputes, which are to be brought forth solely by the Team Captain. Decisions of the head judge are final. Results posted at the competition are not subject to review after the competition.

**Scoring Example:** Assume a team constructs a wall with following characteristics

- Report Score: 48/60,  $R = 48$
- Design report specifies 8.57 g of reinforcement. Reinforced used is 8.25 g. From Equation 1,

$$M = \max \left\{ \begin{array}{l} (8.57 - 0.25) - \frac{8.57 - 8.25 - 0.25}{2} = 8.29g \\ 8.25 + \frac{8.25 - 8.57 - 0.25}{2} = 7.97g \end{array} \right. = 8.29g$$

- Minor deduction for tape overlapping on wall,  $N_{min} = 1$
- Execution times were
  - Reinforcement fabrication: 15:18 (18 sec over allotted time, round up to 1 min)
  - Wall assembly: 16:05 (1:05 over allotted time, round up to 2 min)
  - Construction: 18:27 min (under allotted time)
  - Total time over: 1+2=3 min,  $T = 3$



Note: Only times over limit during each stage are counted. Teams get no benefit for times under the limit of any individual stage.

- Wall passed deflection tests during initial loading without surcharge and the vertical surcharge loading, but failed deflection test during the horizontal surcharge loading phase,  $D = 4$

Using Equation 2, the final score would be

$$\text{Score} = 48 + 15(40 - 8.29) - 10(1) - 40(0) - 2(3) - 20(4) = 427.7$$

See Appendix D for scoring checklists.

14. **Pre-Competition Team Captains' Meeting** – A team captains' meeting will be held prior to the competition for the purposes of: checking sandboxes, PVC tunnel and PVC piles for compliance, establishing competition order, gathering team biographical information, and disseminating any logistical or administrative information. This is a MANDATORY meeting. Each team must have the team captain (or designee) present. All team members are encouraged to attend. Specific meeting time and location will be announced on the Geotechnical Frontiers 2025 website before the conference. Teams without a representative at the captains' meeting may be disqualified.

Teams must bring their sandboxes, PVC tunnel, PVC piles, any hardware or tools needed for assembly, and all temporary templates that will be used in any stage of the competition. Sandboxes, tunnels, and piles should be assembled and will be checked for compliance at the meeting. Teams will have until 9:45 am local time of the day of the competition to correct any compliance issues identified during the captains' meeting. Any sandboxes, tunnels, or piles found out of compliance at the captains' meeting will be rechecked at this time.

Teams shall complete Appendices F and G and bring copies to the captains' meeting. The information on these forms will be used by the emcee during the competition.

## Appendices

### Appendix A: Reimbursements

*This form is to be submitted with your design report.*

This year, any monies due to competitors will be paid to a representative of your university. Examples of valid representatives are your faculty advisor or your departmental accounting administrative assistant. Unacceptable representatives include students, parents, friends, etc.

Please provide complete contact information for this representative.

School	
Name of Representative	
Position at Institution	
Name on Check (Check Should be Made Out To:)	
Complete Mailing Address	
Phone	
Email Address	
Signature of Faculty Advisor	

## Appendix B: Material Specifications

- **Sand:**
  - Clean sand with grain size distribution as specified in Table 1 and Figure 7
  - Grain shape will be rounded to sub-rounded
- **Sandbox Material:**
  - Walls and Base: 23/32 inch or ¾ inch plywood, any grade
  - Pile Guide: any wood material ¼ inch thick or less
  - Tie Rod: ¼ inch threaded steel rod with washers and nuts as needed
  - Fasteners: any suitable wood fasteners
- **Pile Material:**
  - 1-½ inch Schedule 40 PVC pipe
- **Tunnel Material:**
  - 3 inch Schedule 40 PVC pipe
  - 3 inch Schedule 40 PVC caps
  - Restraints: any suitable removal screws
- **Horizontal Loading Frame Materials:** These are recommended materials. Teams may fabricate their load frames out of any material so long as they have the correct moment arm, as shown in Figures 5 and 6. The load frames provided by the organizers for the competition will use the following materials and meet dimensions shown in Figure 6.
  - 1-¼ inch steel EMT conduit (thin wall electrical conduit)
  - ¾ inch steel L
  - ¾ inch bolts
  - ¼ inch eye hooks
- **Facing Material:**
  - Poster Board, 22 inch x 28 inch, White
  - Grammage: 194 g/m<sup>2</sup>, 0.125 g/in<sup>2</sup>
  - Office Depot® Item # 858277 (Pack Of 10)
- **Reinforcing Material:**
  - 60 lb kraft paper
  - Grammage: 97.7 g/m<sup>2</sup>, 0.063 g/in<sup>2</sup>
  - Office Depot® Postal Wrap Item # 444835 (2 ft x 50 ft roll)
- **Adhesive Material:**
  - Heavy duty, clear, 2 inch wide, polypropylene package tape
  - Scotch® 142-B Super Strength Mailing Tape, clear
  - Office Depot® Item #650457, 2 inch x 22.2 yd with dispenser
- **Vertical and Horizontal Surcharge Buckets:**
  - 5 gallon Home Depot Bucket
  - Home Depot Internet SKU #100087613

## Appendix C: Design Report Judging Rubric

<b>Geo-Institute of the ASCE: GeoWall Design Paper – Scoring Form</b>			
<b>Reviewer Guidelines:</b> 1) Place weight on the team ability for engineering reasoning not technical knowledge; 2) Place weight on team communication skills on procedures, findings and observations; 3) Score in 0.5-point increments; and 4) Team to be awarded higher score if design parameters were verified beyond assumptions and references. Max = maximum number of points; Act = points awarded.			
<b>Criterion</b>	<b>Max</b>	<b>Act</b>	<b>Notes</b>
<b>1) Formatting, Mechanics, Grammar &amp; Safety</b>			
a. Paper length, margins & font are acceptable	2		Paper complies with specifications
b. Layout, or structure, of paper is logical	2		Paper organization is clear and supports the message
c. Grammar and punctuation are correct	2		Error free paper with writing that clearly presents design
d. Figures & tables are clear, properly numbered, captioned and referenced in the text	3		Good choice of tables vs. figures, clear presentation of data
e. References are reasonably formatted and complete	2		Quantity appropriate with correct citations and references
f. Reimbursement appendix (Appendix A)	1		Follows the format given
g. Safety appendix (Appendix E) complete with reasonable controls	2		Clearly identifies key safety concerns and provides viable plans to keep team safe during competition; Follows the format given
<b>2) Experimental Methods, Analyses and Design</b>			
a. Methods to obtain soil properties	3		Experimental methods are reasonable and clearly described
b. Methods to determine reinforcement properties	3		Experimental methods are reasonable and clearly described
c. Methods to determine backfill-reinforcement interaction	3		Experimental methods are reasonable and clearly described
d. Engineering properties are reasonable	3		Backfill unit weight, friction angle, interface friction angle, reinforcement strength are compared to typical values
e. Earth-pressure calculations (backfill only)	3		Calculations are correct and presented in a logical, readily followed format
f. Vertical surcharge load included in the design	4		Considers lateral loads on wall and effect on reinforcement pullout
g. Methods used to compute pressure applied from laterally loaded piles addressed in report	4		Considers distribution of lateral load on wall; Models and assumptions are reasonable
h. Methods used to account for effects of tunnel	4		Method and assumptions are reasonable
i. Determination of reinforcement length	3		Method and assumptions are reasonable
j. Determination of reinforcement spacing	3		Method and assumptions are reasonable
k. Evaluation of connection strength	3		Method and assumptions are reasonable
<b>3) Engineering Reasoning and Communication</b>			
The report is, on the whole, clear, precise, and well-reasoned. Engineering terms and distinctions are used effectively and in keeping with established professional usage. The report demonstrates a clear and precise analysis of the MSE wall design problem, very little or no irrelevant information is presented, key assumptions are identified, and key concepts are clarified. The authors have shown, through their report, excellent engineering reasoning and problem-solving skills.	10		Scores may range from 0 to 10. It is the opinion of the reviewer as to how the overall report measures up to the criteria listed under item 3, "engineering reasoning and communication".
<b>Total</b>	<b>60</b>		

## Appendix D: Judges’ Scoring Checklist for GeoWall Competition

### D1: Captains’ meeting—Box check

Team School:		Deductions	
Item	Instruction	Minor	Major
Plywood	<input type="checkbox"/> 23/32-inch or ¾-inch thickness <input type="checkbox"/> Inside surfaces planar and natural		
Box dimensions	<input type="checkbox"/> Within tolerance <input type="checkbox"/> Sand fill height marked		
Facing panels	<input type="checkbox"/> Flush to box base <input type="checkbox"/> Removable fasteners <input type="checkbox"/> Base extends to outside of vertical facing panel		
Tie rod	<input type="checkbox"/> ¼-inch diameter <input type="checkbox"/> Located within tolerances		
Tunnel	<input type="checkbox"/> 3-inch Sch. 40 PVC pipe <input type="checkbox"/> 3-inch Sch. 40 PVC caps <input type="checkbox"/> Length in tolerance <input type="checkbox"/> Locations in tolerance <input type="checkbox"/> Restraints are easily removable		
Piles	<input type="checkbox"/> 1-½ inch Sch. 40 PVC <input type="checkbox"/> Length in tolerance <input type="checkbox"/> Base guides ≤ ¼-inch thick <input type="checkbox"/> Locations in tolerance <input type="checkbox"/> Upper pile template easily removable		
Tools	<input type="checkbox"/> Only authorized tools used		
Other minor, explain:			
Other major, explain:			
Disqualification, explain:			
<b>Total deductions</b>			

Notes:

**D2: Reinforcement fabrication**

Item		Instruction		Time	
				<b>Total</b>	<b>&gt; 15:00 (min:sec)</b>
Time	Give start command. Time ends when all elements cut to size and shape				
				<b>Mass (g)</b>	
				<b>Design</b>	<b>Actual</b>
Mass	Weigh reinforcement to nearest 0.01 g				
Compute official adjusted Mass, $M$ , using Equation 2				$M =$	
				<b>Deductions</b>	
<b>Deductions</b>				<b>Minor</b>	<b>Major</b>
Tools	<input type="checkbox"/> Only authorized tools used				
Safety	<input type="checkbox"/> No mishaps				
<b>Total deductions</b>					

Notes:

**D3: Wall assembly**

Item		Instruction		Time	
				<b>Total</b>	<b>&gt; 15:00 (min:sec)</b>
Time	Give start command. Time ends when soil filled to line and empty loading platform is in place				
				<b>Deductions</b>	
				<b>Minor</b>	<b>Major</b>
Backfill	<input type="checkbox"/> Level <input type="checkbox"/> Filled to fill line				
Tools	<input type="checkbox"/> Only authorized tools used				
Safety	<input type="checkbox"/> No mishaps				
<b>Total deductions</b>					

Notes:

**D4: Construction**

Item	Instruction	Time	
		Total	> 20:00 (min:sec)
Time	Give start command. Time ends when soil filled to line and empty bucket is in place		
		<b>Deductions</b>	
		<b>Minor</b>	<b>Major</b>
Backfill	<input type="checkbox"/> Level <input type="checkbox"/> Filled to fill line		
Tools	<input type="checkbox"/> Only authorized tools used		
Safety	<input type="checkbox"/> No mishaps		
<b>Total deductions</b>			

Notes:

**D5: Loading**

Team School:			
Item	Instruction	Scoring Guidelines	
Stage 1: Backfill Only	<ul style="list-style-type: none"> <li>Place clean poster board on floor in front of box</li> <li>Students install horizontal loading frame and bring two pre-weighed buckets. One bucket should contain 50 lbs of sand and the other 20 lbs of sand.</li> <li>At judge’s direction, students remove tunnel restraints and front panel from box. Electric drills/screwdrivers may be used to remove fasteners.</li> <li>Once the tunnel restraints and the front panel are both completely removed, start 1 min wait period.</li> <li>At end of 1 min, make following checks:</li> </ul>		
	<input type="checkbox"/> Swipe front wall front and sides with straight edge to check wall deflection	<input type="checkbox"/> Pass	<input type="checkbox"/> Fail <i>D</i> = 8
	<input type="checkbox"/> Less than 30 cm <sup>3</sup> sand leaked from box onto floor	<input type="checkbox"/> Pass	<input type="checkbox"/> Fail Major Ded.
	<input type="checkbox"/> Catastrophic failure	<input type="checkbox"/> Pass	<input type="checkbox"/> Fail Disqualified
Stage 2: Vertical Surcharge	<ul style="list-style-type: none"> <li>Bucket pre-weighed with 50 lbs of sand should be ready.</li> <li>At judge’s direction, students add 50 lbs of sand to surcharge bucket. Students have 1 min to complete loading.</li> <li>Once load is placed, start 1 min wait period.</li> <li>At end of 1 min, make following checks:</li> </ul>		
	<input type="checkbox"/> Loading complete within 1 minute	<input type="checkbox"/> Yes	<input type="checkbox"/> No Minor Ded.
	<input type="checkbox"/> Swipe wall front with straight edge to check wall deflection	<input type="checkbox"/> Pass	<input type="checkbox"/> Fail <i>D</i> = 6
	<input type="checkbox"/> Less than 30 cm <sup>3</sup> sand leaked from box onto floor	<input type="checkbox"/> Pass	<input type="checkbox"/> Fail Major Ded.
	<input type="checkbox"/> Catastrophic failure	<input type="checkbox"/> Pass	<input type="checkbox"/> Fail Disqualified
Stage 3: Horizontal Surcharge	<ul style="list-style-type: none"> <li>Bucket pre-weighed with 20 lbs of sand should be ready.</li> <li>At judge’s direction, students add 20 lbs of sand to horizontal surcharge bucket. Students have 1 min to complete loading.</li> <li>Once load is placed, start 1 min wait period.</li> <li>At end of 1 min, make following checks:</li> </ul>		
	<input type="checkbox"/> Loading complete within 1 minute	<input type="checkbox"/> Yes	<input type="checkbox"/> No Minor Ded.
	<input type="checkbox"/> Swipe wall front with straight edge to check wall deflection	<input type="checkbox"/> Pass	<input type="checkbox"/> Fail <i>D</i> = 4
	<input type="checkbox"/> Less than 30 cm <sup>3</sup> sand leaked from box onto floor	<input type="checkbox"/> Pass	<input type="checkbox"/> Fail Major Ded.
	<input type="checkbox"/> Catastrophic failure	<input type="checkbox"/> Pass	<input type="checkbox"/> Fail Disqualified



**D6: Scoring**

Adjusted mass,  $M$ , computed by

$$\begin{aligned}
 &\text{if } |m_D - m_A| \leq 0.25 && M = m_A \\
 &\text{if } |m_D - m_A| > 0.25 && M = \max \left[ \begin{aligned} &(m_D - 0.25) - \frac{(m_D - m_A - 0.25)}{2} \\ &m_A + \frac{(m_A - m_D - 0.25)}{2} \end{aligned} \right]
 \end{aligned}$$

$$\text{Score} = R + 15(40 - M) - 10N_{min} - 40N_{maj} - 2T - 20D$$

<b>Team School:</b>			
<b>Item</b>	<b>Score</b>	<b>Weight</b>	<b>Extended</b>
Report score out of 60, $R$		1	
Reinforcement mass score, enter as $(40 - M)$		15	
Total # of minor deductions, $N_{min}$		-10	
Total # of major deductions, $N_{maj}$		-40	
Total time over limit rounded up to nearest whole minute, $T$		-2	
Deflection rating, $D$ 8 = Deflection exceeded at Stage 1 6 = Deflection exceeded at Stage 2 4 = Deflection exceeded at Stage 3 0 = Deflection never exceeded		-20	
Catastrophic failure any stage disqualifies the team	<b>DQ</b>	<b>Stage #</b>	
		<b>Final Score</b>	

Notes:

## Appendix E: Safety Appendix

This section is intended for each team to consider the competition steps and manage safety risk. Use additional rows as necessary.

Title	Work Task	Hazards	Controls

### Notes:

- 1) *Proper personal protective equipment (PPE; such as, masks, safety goggles, closed toed shoes, gloves, etc.) should be identified and used during the competition. Failing to use PPE will result in major and/or minor penalties based on judges' discretion.*
- 2) *At a minimum, closed toed shoes, eye protection, and respiratory dust protection are required for all team members. Each missing occurrence of this minimum PPE will be incur a minor penalty. After three reminders from the judges to use the proper PPE, the team will incur a major penalty for each occurrence.*
- 3) *Safety mishaps that result in bleeding will be classified as "major."*

**Appendix F: Bio-form to be completed by the team captain and submitted to the head judge at the pre-competition meeting**

<p><b>Geo-Institute of ASCE</b>  <b>Geotechnical Frontiers 2025</b>  <b>GeoWall Competition Bios</b></p>
Team School:
Team Mascot:
No. of Years Competing at Nationals:
Team Advisor:
<b>Team Captain:</b>
Current Year in School (freshman, sophomore, junior, senior, MS, or PhD):
Hometown (City and State or Country)
Other School Activities:
Interests/Hobbies:
Future Plans, e.g., graduate school, consulting, government, other?
Geographical preferences?

**Appendix G: Bio-form to be completed by each team member and submitted to the head judge at the pre-competition meeting**

<p><b>Geo-Institute of ASCE</b>  <b>Geotechnical Frontiers 2025</b>  <b>GeoWall Competition Bios</b></p>
Team School:
Team Mascot:
No. of Years Competing at Nationals:
Team Advisor:
<b>Team Member:</b>
Current Year in School (freshman, sophomore, junior, senior, MS, or PhD):
Hometown (City and State or Country)
Other School Activities:
Interests/Hobbies:
Future Plans, e.g., graduate school, consulting, government, other?
Geographical preferences?